

Printed 3/28/2018

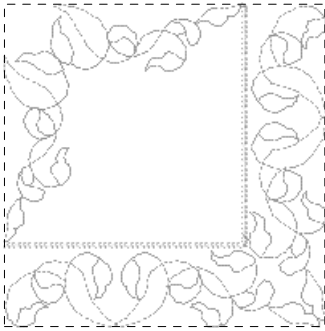

1. White (Mar:1348)

**Design1 5x5.pes**  
4.98x5.01 inches; 3,299 stitches  
1 thread changes; 1 colors

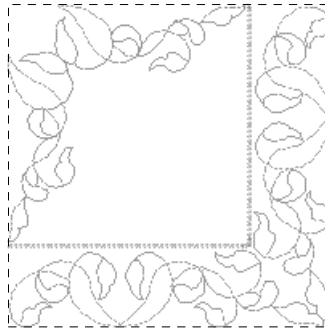

1. White (Mar:1348)

**Design1 6x6.pes**  
5.98x6.01 inches; 3,653 stitches  
1 thread changes; 1 colors



1. White (Mar:1348)

**Design1 7x7.pes**  
6.98x7.00 inches; 3,975 stitches  
1 thread changes; 1 colors

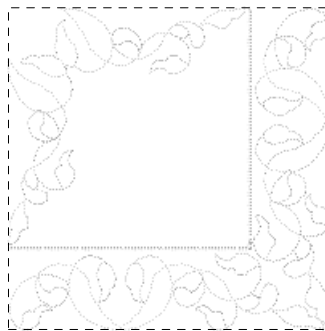

1. White (Mar:1348)

**Design1 8x8.pes**  
7.98x8.00 inches; 4,385 stitches  
1 thread changes; 1 colors



1. White (Mar:1179)  
2. Copper Salmon (Mar:1033)  
3. Pasture (Mar:1123)  
4. Savage Red (Mar:1335)  
5. Soft Turquoise (Mar:1205)  
6. Noon Sun (Mar:1008)  
7. Livery Green (Mar:1207)  
8. Alpine Stream (Mar:1095)  
9. Dusty Pink (Mar:1229)

**Design10 5x5.pes**  
4.98x5.01 inches; 9,016 stitches  
9 thread changes; 9 colors

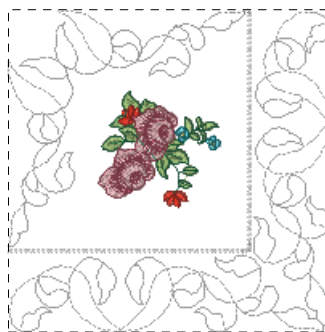

1. White (Mar:1179)  
2. Copper Salmon (Mar:1033)  
3. Pasture (Mar:1123)  
4. Savage Red (Mar:1335)  
5. Soft Turquoise (Mar:1205)  
6. Noon Sun (Mar:1008)  
7. Livery Green (Mar:1207)  
8. Alpine Stream (Mar:1095)  
9. Dusty Pink (Mar:1229)

**Design10 6x6.pes**  
5.98x6.01 inches; 10,486 stitches  
9 thread changes; 9 colors



1. White (Mar:1179)  
2. Copper Salmon (Mar:1033)  
3. Pasture (Mar:1123)  
4. Savage Red (Mar:1335)  
5. Soft Turquoise (Mar:1205)  
6. Noon Sun (Mar:1008)  
7. Livery Green (Mar:1207)  
8. Alpine Stream (Mar:1095)  
9. Dusty Pink (Mar:1229)

**Design10 7x7.pes**  
6.98x7.00 inches; 12,069 stitches  
9 thread changes; 9 colors

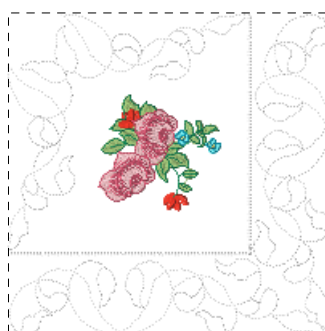

1. White (Mar:1179)  
2. Copper Salmon (Mar:1033)  
3. Pasture (Mar:1123)  
4. Savage Red (Mar:1335)  
5. Soft Turquoise (Mar:1205)  
6. Noon Sun (Mar:1008)  
7. Livery Green (Mar:1207)  
8. Alpine Stream (Mar:1095)  
9. Dusty Pink (Mar:1229)

**Design10 8x8.pes**  
7.98x8.00 inches; 13,689 stitches  
9 thread changes; 9 colors

Printed 3/28/2018



- 1. White (Mar:1348)
- 2. Copper Salmon (Mar:1033)
- 3. Pasture (Mar:1123)
- 4. Savage Red (Mar:1335)
- 5. Soft Torquoise (Mar:1205)
- 6. Clouded Dawning (Mar:1148)
- 7. Noon Sun (Mar:1008)
- 8. Livery Green (Mar:1207)
- 9. Alpine Stream (Mar:1095)
- 10. Copper Purple (Mar:1089)
- 11. Dusty Pink (Mar:1229)

**Design11 5x5.pes**  
 4.98x5.01 inches; 8,575 stitches  
 11 thread changes; 11 colors

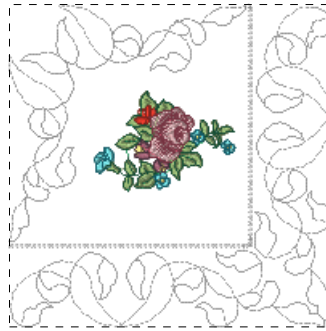

- 1. White (Mar:1348)
- 2. Copper Salmon (Mar:1033)
- 3. Pasture (Mar:1123)
- 4. Savage Red (Mar:1335)
- 5. Soft Torquoise (Mar:1205)
- 6. Clouded Dawning (Mar:1148)
- 7. Noon Sun (Mar:1008)
- 8. Livery Green (Mar:1207)
- 9. Alpine Stream (Mar:1095)
- 10. Copper Purple (Mar:1089)
- 11. Dusty Pink (Mar:1229)

**Design11 6x6.pes**  
 5.98x6.01 inches; 9,875 stitches  
 11 thread changes; 11 colors



- 1. White (Mar:1348)
- 2. Copper Salmon (Mar:1033)
- 3. Pasture (Mar:1123)
- 4. Savage Red (Mar:1335)
- 5. Soft Torquoise (Mar:1205)
- 6. Clouded Dawning (Mar:1148)
- 7. Noon Sun (Mar:1008)
- 8. Livery Green (Mar:1207)
- 9. Alpine Stream (Mar:1095)
- 10. Copper Purple (Mar:1089)
- 11. Dusty Pink (Mar:1229)

**Design11 7x7.pes**  
 6.98x7.00 inches; 11,386 stitches  
 11 thread changes; 11 colors

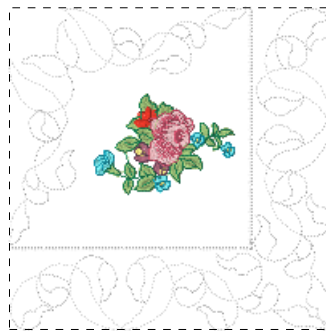

- 1. White (Mar:1348)
- 2. Copper Salmon (Mar:1033)
- 3. Pasture (Mar:1123)
- 4. Savage Red (Mar:1335)
- 5. Soft Torquoise (Mar:1205)
- 6. Clouded Dawning (Mar:1148)
- 7. Noon Sun (Mar:1008)
- 8. Livery Green (Mar:1207)
- 9. Alpine Stream (Mar:1095)
- 10. Copper Purple (Mar:1089)
- 11. Dusty Pink (Mar:1229)

**Design11 8x8.pes**  
 7.98x8.00 inches; 12,958 stitches  
 11 thread changes; 11 colors

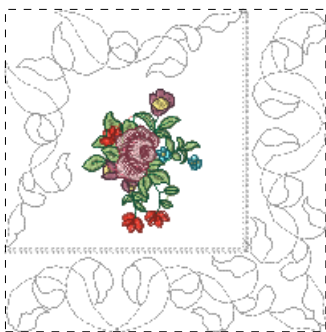

- 1. White (Mar:1179)
- 2. Copper Salmon (Mar:1033)
- 3. Pasture (Mar:1123)
- 4. Savage Red (Mar:1335)
- 5. Soft Torquoise (Mar:1205)
- 6. Clouded Dawning (Mar:1148)
- 7. Noon Sun (Mar:1008)
- 8. Livery Green (Mar:1207)
- 9. Copper Purple (Mar:1089)
- 10. Alpine Stream (Mar:1095)
- 11. Copper Purple (Mar:1089)
- 12. Dusty Pink (Mar:1229)

**Design12 5x5.pes**  
 4.98x5.01 inches; 8,933 stitches  
 12 thread changes; 11 colors

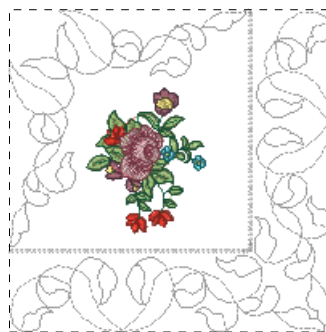

- 1. White (Mar:1179)
- 2. Copper Salmon (Mar:1033)
- 3. Pasture (Mar:1123)
- 4. Savage Red (Mar:1335)
- 5. Soft Torquoise (Mar:1205)
- 6. Clouded Dawning (Mar:1148)
- 7. Noon Sun (Mar:1008)
- 8. Livery Green (Mar:1207)
- 9. Copper Purple (Mar:1089)
- 10. Alpine Stream (Mar:1095)
- 11. Copper Purple (Mar:1089)
- 12. Dusty Pink (Mar:1229)

**Design12 6x6.pes**  
 5.98x6.01 inches; 10,311 stitches  
 12 thread changes; 11 colors



- 1. White (Mar:1179)
- 2. Copper Salmon (Mar:1033)
- 3. Pasture (Mar:1123)
- 4. Savage Red (Mar:1335)
- 5. Soft Torquoise (Mar:1205)
- 6. Clouded Dawning (Mar:1148)
- 7. Noon Sun (Mar:1008)
- 8. Livery Green (Mar:1207)
- 9. Copper Purple (Mar:1089)
- 10. Alpine Stream (Mar:1095)
- 11. Copper Purple (Mar:1089)
- 12. Dusty Pink (Mar:1229)

**Design12 7x7.pes**  
 6.98x7.00 inches; 11,820 stitches  
 12 thread changes; 11 colors



- 1. White (Mar:1179)
- 2. Copper Salmon (Mar:1033)
- 3. Pasture (Mar:1123)
- 4. Savage Red (Mar:1335)
- 5. Soft Torquoise (Mar:1205)
- 6. Clouded Dawning (Mar:1148)
- 7. Noon Sun (Mar:1008)
- 8. Livery Green (Mar:1207)
- 9. Copper Purple (Mar:1089)
- 10. Alpine Stream (Mar:1095)
- 11. Copper Purple (Mar:1089)
- 12. Dusty Pink (Mar:1229)

**Design12 8x8.pes**  
 7.98x8.00 inches; 13,500 stitches  
 12 thread changes; 11 colors

Printed 3/28/2018



- 1. White (Mar:1348)
- 2. Copper Salmon (Mar:1033)
- 3. Pasture (Mar:1123)
- 4. Savage Red (Mar:1335)
- 5. Soft Torquoise (Mar:1205)
- 6. Noon Sun (Mar:1008)
- 7. Livery Green (Mar:1207)
- 8. Alpine Stream (Mar:1095)
- 9. Dusty Pink (Mar:1229)

**Design13 5x5.pes**  
 4.98x5.01 inches; 7,416 stitches  
 9 thread changes; 9 colors



- 1. White (Mar:1179)
- 2. Copper Salmon (Mar:1033)
- 3. Pasture (Mar:1123)
- 4. Savage Red (Mar:1335)
- 5. Soft Torquoise (Mar:1205)
- 6. Noon Sun (Mar:1008)
- 7. Livery Green (Mar:1207)
- 8. Alpine Stream (Mar:1095)
- 9. Dusty Pink (Mar:1229)

**Design13 6x6.pes**  
 5.98x6.01 inches; 8,579 stitches  
 9 thread changes; 9 colors



- 1. White (Mar:1348)
- 2. Copper Salmon (Mar:1033)
- 3. Pasture (Mar:1123)
- 4. Savage Red (Mar:1335)
- 5. Soft Torquoise (Mar:1205)
- 6. Noon Sun (Mar:1008)
- 7. Livery Green (Mar:1207)
- 8. Alpine Stream (Mar:1095)
- 9. Dusty Pink (Mar:1229)

**Design13 7x7.pes**  
 6.98x7.00 inches; 9,777 stitches  
 9 thread changes; 9 colors



- 1. White (Mar:1179)
- 2. Copper Salmon (Mar:1033)
- 3. Pasture (Mar:1123)
- 4. Savage Red (Mar:1335)
- 5. Soft Torquoise (Mar:1205)
- 6. Noon Sun (Mar:1008)
- 7. Livery Green (Mar:1207)
- 8. Alpine Stream (Mar:1095)
- 9. Dusty Pink (Mar:1229)

**Design13 8x8.pes**  
 7.98x8.00 inches; 11,105 stitches  
 9 thread changes; 9 colors

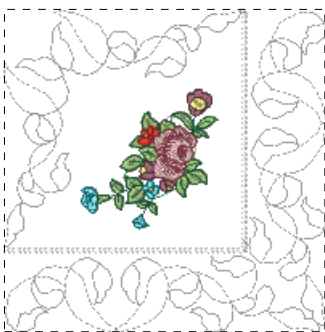

- 1. White (Mar:1348)
- 2. Copper Salmon (Mar:1033)
- 3. Pasture (Mar:1123)
- 4. Savage Red (Mar:1335)
- 5. Soft Torquoise (Mar:1205)
- 6. Clouded Dawning (Mar:1148)
- 7. Noon Sun (Mar:1008)
- 8. Livery Green (Mar:1207)
- 9. Alpine Stream (Mar:1095)
- 10. Copper Purple (Mar:1089)
- 11. Alpine Stream (Mar:1095)
- 12. Dusty Pink (Mar:1229)

**Design14 5x5.pes**  
 4.98x5.01 inches; 8,825 stitches  
 12 thread changes; 11 colors

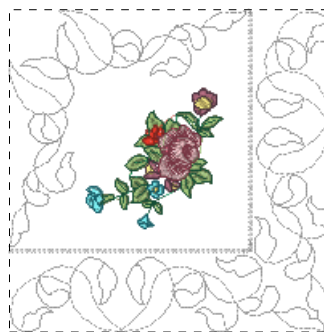

- 1. White (Mar:1348)
- 2. Copper Salmon (Mar:1033)
- 3. Pasture (Mar:1123)
- 4. Savage Red (Mar:1335)
- 5. Soft Torquoise (Mar:1205)
- 6. Clouded Dawning (Mar:1148)
- 7. Noon Sun (Mar:1008)
- 8. Livery Green (Mar:1207)
- 9. Alpine Stream (Mar:1095)
- 10. Copper Purple (Mar:1089)
- 11. Alpine Stream (Mar:1095)
- 12. Dusty Pink (Mar:1229)

**Design14 6x6.pes**  
 5.98x6.01 inches; 10,214 stitches  
 12 thread changes; 11 colors



- 1. White (Mar:1179)
- 2. Copper Salmon (Mar:1033)
- 3. Pasture (Mar:1123)
- 4. Savage Red (Mar:1335)
- 5. Soft Torquoise (Mar:1205)
- 6. Clouded Dawning (Mar:1148)
- 7. Noon Sun (Mar:1008)
- 8. Livery Green (Mar:1207)
- 9. Alpine Stream (Mar:1095)
- 10. Copper Purple (Mar:1089)
- 11. Alpine Stream (Mar:1095)
- 12. Dusty Pink (Mar:1229)

**Design14 7x7.pes**  
 6.98x7.00 inches; 11,687 stitches  
 12 thread changes; 11 colors

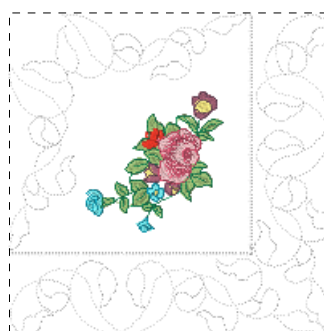

- 1. White (Mar:1348)
- 2. Copper Salmon (Mar:1033)
- 3. Pasture (Mar:1123)
- 4. Savage Red (Mar:1335)
- 5. Soft Torquoise (Mar:1205)
- 6. Clouded Dawning (Mar:1148)
- 7. Noon Sun (Mar:1008)
- 8. Livery Green (Mar:1207)
- 9. Alpine Stream (Mar:1095)
- 10. Copper Purple (Mar:1089)
- 11. Alpine Stream (Mar:1095)
- 12. Dusty Pink (Mar:1229)

**Design14 8x8.pes**  
 7.98x8.00 inches; 13,501 stitches  
 12 thread changes; 11 colors





1. White (Mar:1348)

**Design2 5x5.pes**  
4.98x4.98 inches; 3,341 stitches  
1 thread changes; 1 colors

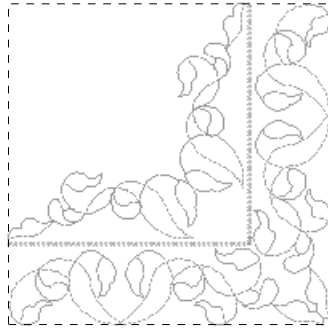

1. White (Mar:1348)

**Design2 6x6.pes**  
5.98x5.98 inches; 3,700 stitches  
1 thread changes; 1 colors

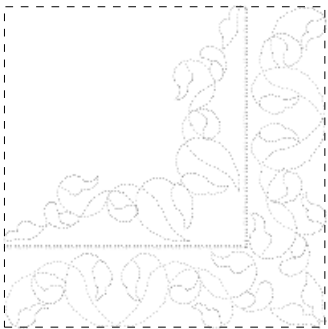

1. White (Mar:1348)

**Design2 7x7.pes**  
6.98x6.98 inches; 4,036 stitches  
1 thread changes; 1 colors

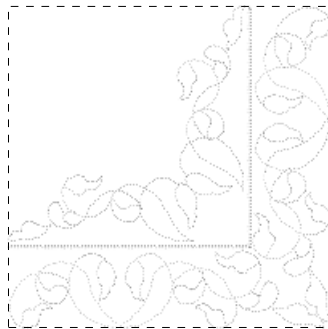

1. White (Mar:1348)

**Design2 8x8.pes**  
7.98x7.98 inches; 4,459 stitches  
1 thread changes; 1 colors



- 1. Copper Salmon (Mar:1033)
- 2. Pasture (Mar:1123)
- 3. Savage Red (Mar:1335)
- 4. Soft Torquoise (Mar:1205)
- 5. Clouded Dawning (Mar:1148)
- 6. Noon Sun (Mar:1008)
- 7. Livery Green (Mar:1207)
- 8. Alpine Stream (Mar:1095)
- 9. Copper Purple (Mar:1089)
- 10. Dusty Pink (Mar:1229)
- 11. White (Mar:1348)

**Design3 5x5.pes**  
4.98x4.98 inches; 10,325 stitches  
11 thread changes; 11 colors



- 1. Copper Salmon (Mar:1033)
- 2. Pasture (Mar:1123)
- 3. Savage Red (Mar:1335)
- 4. Soft Torquoise (Mar:1205)
- 5. Clouded Dawning (Mar:1148)
- 6. Noon Sun (Mar:1008)
- 7. Livery Green (Mar:1207)
- 8. Alpine Stream (Mar:1095)
- 9. Copper Purple (Mar:1089)
- 10. Dusty Pink (Mar:1229)
- 11. White (Mar:1348)

**Design3 6x6.pes**  
5.98x5.98 inches; 12,013 stitches  
11 thread changes; 11 colors



- 1. Copper Salmon (Mar:1033)
- 2. Pasture (Mar:1123)
- 3. Savage Red (Mar:1335)
- 4. Soft Torquoise (Mar:1205)
- 5. Clouded Dawning (Mar:1148)
- 6. Noon Sun (Mar:1008)
- 7. Alpine Stream (Mar:1095)
- 8. Copper Purple (Mar:1089)
- 9. Dusty Pink (Mar:1229)
- 10. White (Mar:1348)

**Design3 7x7.pes**  
6.98x6.98 inches; 12,347 stitches  
10 thread changes; 10 colors



- 1. Copper Salmon (Mar:1033)
- 2. Pasture (Mar:1123)
- 3. Savage Red (Mar:1335)
- 4. Soft Torquoise (Mar:1205)
- 5. Clouded Dawning (Mar:1148)
- 6. Noon Sun (Mar:1008)
- 7. Alpine Stream (Mar:1095)
- 8. Copper Purple (Mar:1089)
- 9. Dusty Pink (Mar:1229)
- 10. White (Mar:1348)

**Design3 8x8.pes**  
7.98x7.98 inches; 14,329 stitches  
10 thread changes; 10 colors

Printed 3/28/2018

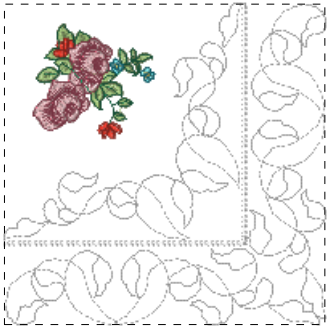

1. White (Mar:1348)  
 2. Copper Salmon (Mar:1033)  
 3. Pasture (Mar:1123)  
 4. Savage Red (Mar:1335)  
 5. Soft Torquoise (Mar:1205)  
 6. Noon Sun (Mar:1008)  
 7. Livery Green (Mar:1207)  
 8. Alpine Stream (Mar:1095)  
 9. Dusty Pink (Mar:1229)

**Design4 5x5.pes**  
 4.98x4.98 inches; 9,063 stitches  
 9 thread changes; 9 colors

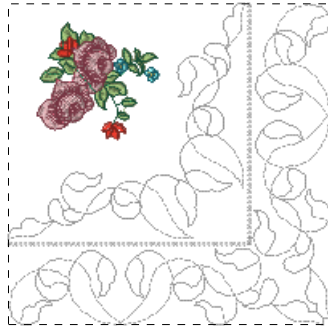

1. White (Mar:1348)  
 2. Copper Salmon (Mar:1033)  
 3. Pasture (Mar:1123)  
 4. Savage Red (Mar:1335)  
 5. Soft Torquoise (Mar:1205)  
 6. Noon Sun (Mar:1008)  
 7. Livery Green (Mar:1207)  
 8. Alpine Stream (Mar:1095)  
 9. Dusty Pink (Mar:1229)

**Design4 6x6.pes**  
 5.98x5.98 inches; 10,522 stitches  
 9 thread changes; 9 colors



1. White (Mar:1348)  
 2. Copper Salmon (Mar:1033)  
 3. Pasture (Mar:1123)  
 4. Savage Red (Mar:1335)  
 5. Soft Torquoise (Mar:1205)  
 6. Noon Sun (Mar:1008)  
 7. Livery Green (Mar:1207)  
 8. Alpine Stream (Mar:1095)  
 9. Dusty Pink (Mar:1229)

**Design4 7x7.pes**  
 6.98x6.98 inches; 11,769 stitches  
 9 thread changes; 9 colors



1. White (Mar:1348)  
 2. Copper Salmon (Mar:1033)  
 3. Pasture (Mar:1123)  
 4. Savage Red (Mar:1335)  
 5. Soft Torquoise (Mar:1205)  
 6. Noon Sun (Mar:1008)  
 7. Livery Green (Mar:1207)  
 8. Alpine Stream (Mar:1095)  
 9. Dusty Pink (Mar:1229)

**Design4 8x8.pes**  
 7.98x7.98 inches; 13,817 stitches  
 9 thread changes; 9 colors

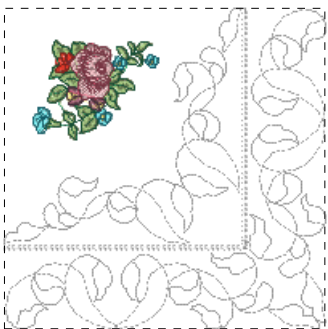

1. White (Mar:1179)  
 2. Copper Salmon (Mar:1033)  
 3. Pasture (Mar:1123)  
 4. Savage Red (Mar:1335)  
 5. Soft Torquoise (Mar:1205)  
 6. Clouded Dawning (Mar:1148)  
 7. Noon Sun (Mar:1008)  
 8. Livery Green (Mar:1207)  
 9. Alpine Stream (Mar:1095)  
 10. Copper Purple (Mar:1089)  
 11. Dusty Pink (Mar:1229)

**Design5 5x5.pes**  
 4.98x4.98 inches; 8,603 stitches  
 11 thread changes; 11 colors



1. White (Mar:1179)  
 2. Copper Salmon (Mar:1033)  
 3. Pasture (Mar:1123)  
 4. Savage Red (Mar:1335)  
 5. Soft Torquoise (Mar:1205)  
 6. Clouded Dawning (Mar:1148)  
 7. Noon Sun (Mar:1008)  
 8. Livery Green (Mar:1207)  
 9. Alpine Stream (Mar:1095)  
 10. Copper Purple (Mar:1089)  
 11. Dusty Pink (Mar:1229)

**Design5 6x6.pes**  
 5.98x5.98 inches; 9,922 stitches  
 11 thread changes; 11 colors

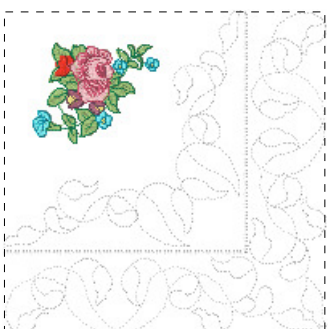

1. White (Mar:1179)  
 2. Copper Salmon (Mar:1033)  
 3. Pasture (Mar:1123)  
 4. Savage Red (Mar:1335)  
 5. Soft Torquoise (Mar:1205)  
 6. Clouded Dawning (Mar:1148)  
 7. Noon Sun (Mar:1008)  
 8. Livery Green (Mar:1207)  
 9. Alpine Stream (Mar:1095)  
 10. Copper Purple (Mar:1089)  
 11. Dusty Pink (Mar:1229)

**Design5 7x7.pes**  
 6.98x6.98 inches; 11,373 stitches  
 11 thread changes; 11 colors

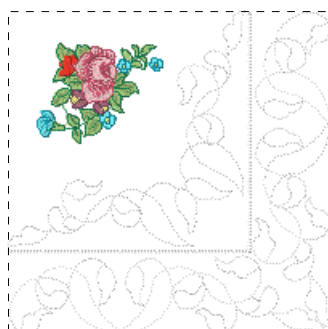

1. White (Mar:1179)  
 2. Copper Salmon (Mar:1033)  
 3. Pasture (Mar:1123)  
 4. Savage Red (Mar:1335)  
 5. Soft Torquoise (Mar:1205)  
 6. Clouded Dawning (Mar:1148)  
 7. Noon Sun (Mar:1008)  
 8. Livery Green (Mar:1207)  
 9. Alpine Stream (Mar:1095)  
 10. Copper Purple (Mar:1089)  
 11. Dusty Pink (Mar:1229)

**Design5 8x8.pes**  
 7.98x7.98 inches; 13,055 stitches  
 11 thread changes; 11 colors

Printed 3/28/2018



- 1. White (Mar:1179)
- 2. Copper Salmon (Mar:1033)
- 3. Pasture (Mar:1123)
- 4. Savage Red (Mar:1335)
- 5. Soft Turquoise (Mar:1205)
- 6. Clouded Dawning (Mar:1148)
- 7. Noon Sun (Mar:1008)
- 8. Livery Green (Mar:1207)
- 9. Copper Purple (Mar:1089)
- 10. Alpine Stream (Mar:1095)
- 11. Copper Purple (Mar:1089)
- 12. Dusty Pink (Mar:1229)

**Design6 5x5.pes**  
 4.98x4.98 inches; 9,009 stitches  
 12 thread changes; 11 colors



- 1. White (Mar:1179)
- 2. Copper Salmon (Mar:1033)
- 3. Pasture (Mar:1123)
- 4. Savage Red (Mar:1335)
- 5. Soft Turquoise (Mar:1205)
- 6. Clouded Dawning (Mar:1148)
- 7. Noon Sun (Mar:1008)
- 8. Livery Green (Mar:1207)
- 9. Copper Purple (Mar:1089)
- 10. Alpine Stream (Mar:1095)
- 11. Copper Purple (Mar:1089)
- 12. Dusty Pink (Mar:1229)

**Design6 6x6.pes**  
 5.98x5.98 inches; 10,380 stitches  
 12 thread changes; 11 colors



- 1. White (Mar:1179)
- 2. Copper Salmon (Mar:1033)
- 3. Pasture (Mar:1123)
- 4. Savage Red (Mar:1335)
- 5. Soft Turquoise (Mar:1205)
- 6. Clouded Dawning (Mar:1148)
- 7. Noon Sun (Mar:1008)
- 8. Livery Green (Mar:1207)
- 9. Copper Purple (Mar:1089)
- 10. Alpine Stream (Mar:1095)
- 11. Copper Purple (Mar:1089)
- 12. Dusty Pink (Mar:1229)

**Design6 7x7.pes**  
 6.98x6.98 inches; 11,838 stitches  
 12 thread changes; 11 colors

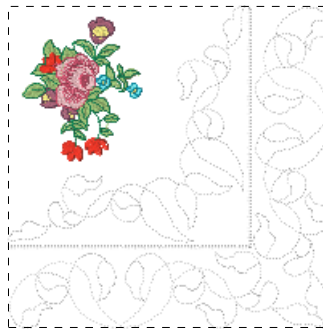

- 1. White (Mar:1179)
- 2. Copper Salmon (Mar:1033)
- 3. Pasture (Mar:1123)
- 4. Savage Red (Mar:1335)
- 5. Soft Turquoise (Mar:1205)
- 6. Clouded Dawning (Mar:1148)
- 7. Noon Sun (Mar:1008)
- 8. Livery Green (Mar:1207)
- 9. Copper Purple (Mar:1089)
- 10. Alpine Stream (Mar:1095)
- 11. Copper Purple (Mar:1089)
- 12. Dusty Pink (Mar:1229)

**Design6 8x8.pes**  
 7.98x7.98 inches; 13,518 stitches  
 12 thread changes; 11 colors

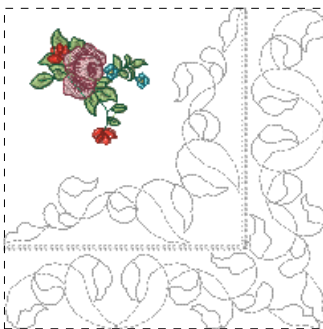

- 1. White (Mar:1348)
- 2. Copper Salmon (Mar:1033)
- 3. Pasture (Mar:1123)
- 4. Savage Red (Mar:1335)
- 5. Soft Turquoise (Mar:1205)
- 6. Noon Sun (Mar:1008)
- 7. Livery Green (Mar:1207)
- 8. Alpine Stream (Mar:1095)
- 9. Dusty Pink (Mar:1229)

**Design7 5x5.pes**  
 4.98x4.98 inches; 7,441 stitches  
 9 thread changes; 9 colors



- 1. White (Mar:1348)
- 2. Copper Salmon (Mar:1033)
- 3. Pasture (Mar:1123)
- 4. Savage Red (Mar:1335)
- 5. Soft Turquoise (Mar:1205)
- 6. Noon Sun (Mar:1008)
- 7. Livery Green (Mar:1207)
- 8. Alpine Stream (Mar:1095)
- 9. Dusty Pink (Mar:1229)

**Design7 6x6.pes**  
 5.98x5.98 inches; 8,630 stitches  
 9 thread changes; 9 colors

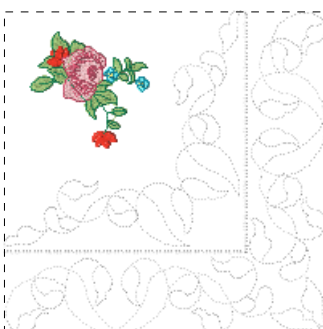

- 1. White (Mar:1348)
- 2. Copper Salmon (Mar:1033)
- 3. Pasture (Mar:1123)
- 4. Savage Red (Mar:1335)
- 5. Soft Turquoise (Mar:1205)
- 6. Noon Sun (Mar:1008)
- 7. Livery Green (Mar:1207)
- 8. Alpine Stream (Mar:1095)
- 9. Dusty Pink (Mar:1229)

**Design7 7x7.pes**  
 6.98x6.98 inches; 9,844 stitches  
 9 thread changes; 9 colors



- 1. White (Mar:1348)
- 2. Copper Salmon (Mar:1033)
- 3. Pasture (Mar:1123)
- 4. Savage Red (Mar:1335)
- 5. Soft Turquoise (Mar:1205)
- 6. Noon Sun (Mar:1008)
- 7. Livery Green (Mar:1207)
- 8. Alpine Stream (Mar:1095)
- 9. Dusty Pink (Mar:1229)

**Design7 8x8.pes**  
 7.98x7.98 inches; 11,141 stitches  
 9 thread changes; 9 colors



Printed 3/28/2018

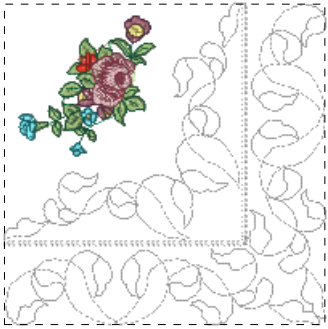

- 1. White (Mar:1179)
- 2. Copper Salmon (Mar:1033)
- 3. Pasture (Mar:1123)
- 4. Savage Red (Mar:1335)
- 5. Soft Torquoise (Mar:1205)
- 6. Clouded Dawning (Mar:1148)
- 7. Noon Sun (Mar:1008)
- 8. Livery Green (Mar:1207)
- 9. Alpine Stream (Mar:1095)
- 10. Copper Purple (Mar:1089)
- 11. Alpine Stream (Mar:1095)
- 12. Dusty Pink (Mar:1229)

**Design8 5x5.pes**  
 4.98x4.98 inches; 8,869 stitches  
 12 thread changes; 11 colors



- 1. White (Mar:1179)
- 2. Copper Salmon (Mar:1033)
- 3. Pasture (Mar:1123)
- 4. Savage Red (Mar:1335)
- 5. Soft Torquoise (Mar:1205)
- 6. Clouded Dawning (Mar:1148)
- 7. Noon Sun (Mar:1008)
- 8. Livery Green (Mar:1207)
- 9. Alpine Stream (Mar:1095)
- 10. Copper Purple (Mar:1089)
- 11. Alpine Stream (Mar:1095)
- 12. Dusty Pink (Mar:1229)

**Design8 6x6.pes**  
 5.98x5.98 inches; 10,259 stitches  
 12 thread changes; 11 colors



- 1. White (Mar:1179)
- 2. Copper Salmon (Mar:1033)
- 3. Pasture (Mar:1123)
- 4. Savage Red (Mar:1335)
- 5. Soft Torquoise (Mar:1205)
- 6. Clouded Dawning (Mar:1148)
- 7. Noon Sun (Mar:1008)
- 8. Livery Green (Mar:1207)
- 9. Alpine Stream (Mar:1095)
- 10. Copper Purple (Mar:1089)
- 11. Alpine Stream (Mar:1095)
- 12. Dusty Pink (Mar:1229)

**Design8 7x7.pes**  
 6.98x6.98 inches; 11,779 stitches  
 12 thread changes; 11 colors

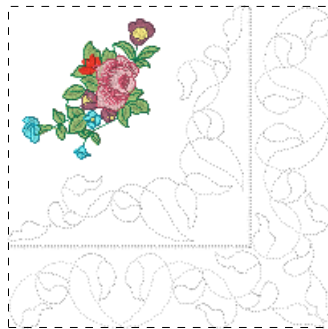

- 1. White (Mar:1179)
- 2. Copper Salmon (Mar:1033)
- 3. Pasture (Mar:1123)
- 4. Savage Red (Mar:1335)
- 5. Soft Torquoise (Mar:1205)
- 6. Clouded Dawning (Mar:1148)
- 7. Noon Sun (Mar:1008)
- 8. Livery Green (Mar:1207)
- 9. Alpine Stream (Mar:1095)
- 10. Copper Purple (Mar:1089)
- 11. Alpine Stream (Mar:1095)
- 12. Dusty Pink (Mar:1229)

**Design8 8x8.pes**  
 7.98x7.98 inches; 13,521 stitches  
 12 thread changes; 11 colors



- 1. Copper Salmon (Mar:1033)
- 2. Pasture (Mar:1123)
- 3. Savage Red (Mar:1335)
- 4. Soft Torquoise (Mar:1205)
- 5. Clouded Dawning (Mar:1148)
- 6. Noon Sun (Mar:1008)
- 7. Livery Green (Mar:1207)
- 8. Alpine Stream (Mar:1095)
- 9. Copper Purple (Mar:1089)
- 10. Dusty Pink (Mar:1229)
- 11. White (Mar:1348)

**Design9 5x5.pes**  
 4.98x5.01 inches; 10,297 stitches  
 11 thread changes; 11 colors

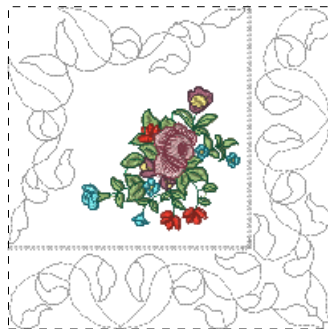

- 1. Copper Salmon (Mar:1033)
- 2. Pasture (Mar:1123)
- 3. Savage Red (Mar:1335)
- 4. Soft Torquoise (Mar:1205)
- 5. Clouded Dawning (Mar:1148)
- 6. Noon Sun (Mar:1008)
- 7. Livery Green (Mar:1207)
- 8. Alpine Stream (Mar:1095)
- 9. Copper Purple (Mar:1089)
- 10. Dusty Pink (Mar:1229)
- 11. White (Mar:1348)

**Design9 6x6.pes**  
 5.98x6.01 inches; 11,990 stitches  
 11 thread changes; 11 colors



- 1. Copper Salmon (Mar:1033)
- 2. Pasture (Mar:1123)
- 3. Savage Red (Mar:1335)
- 4. Soft Torquoise (Mar:1205)
- 5. Clouded Dawning (Mar:1148)
- 6. Noon Sun (Mar:1008)
- 7. Livery Green (Mar:1207)
- 8. Alpine Stream (Mar:1095)
- 9. Copper Purple (Mar:1089)
- 10. Dusty Pink (Mar:1229)
- 11. White (Mar:1348)

**Design9 7x7.pes**  
 6.98x7.00 inches; 13,678 stitches  
 11 thread changes; 11 colors

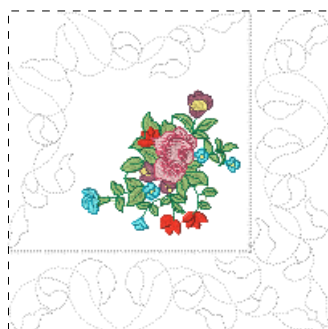

- 1. Copper Salmon (Mar:1033)
- 2. Pasture (Mar:1123)
- 3. Savage Red (Mar:1335)
- 4. Soft Torquoise (Mar:1205)
- 5. Clouded Dawning (Mar:1148)
- 6. Noon Sun (Mar:1008)
- 7. Livery Green (Mar:1207)
- 8. Alpine Stream (Mar:1095)
- 9. Copper Purple (Mar:1089)
- 10. Dusty Pink (Mar:1229)
- 11. White (Mar:1348)

**Design9 8x8.pes**  
 7.98x8.00 inches; 15,720 stitches  
 11 thread changes; 11 colors